

Ice Cube Storage Bin

SKOPE ID: SILO S500

Machine Dimensions: 1321 W x 872 D x 1122 (1275 with legs) H (mm)

Packed Dimensions: 1150 W x 890 D x 1210 H (mm)

Weight: 94kg

Floor Area: 1.86m³

Storage Bin Capacity: 480kg

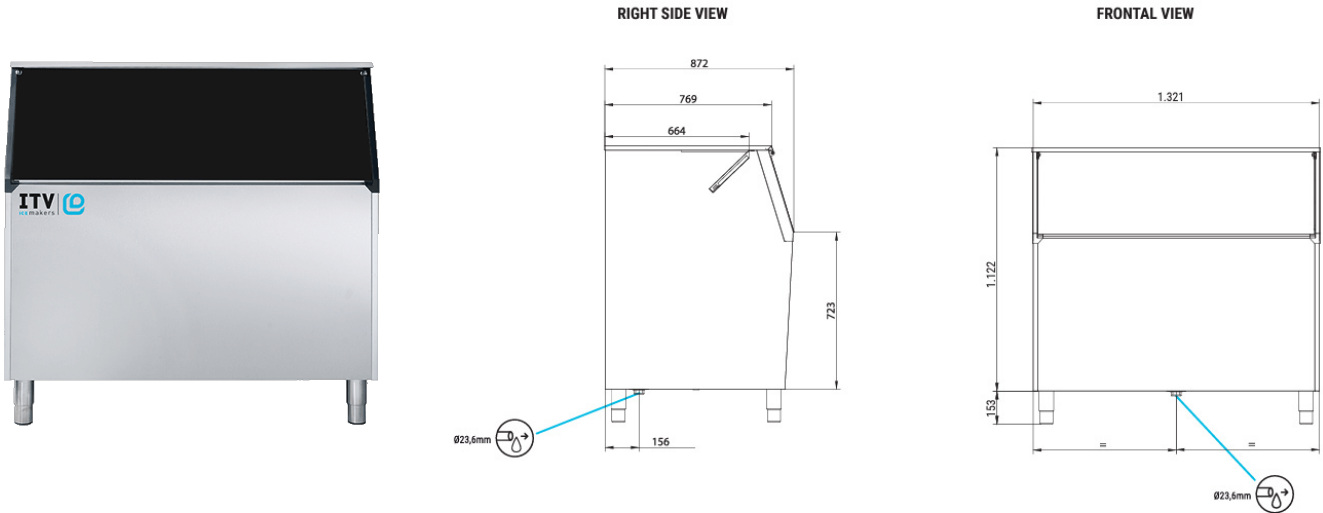

Description

Ice cube storage bin that can be used with a Modular Ice Maker, indispensable for scaled up ice production requirements, plus it also benefits service delivery by helping to avoid ice spills and speeding up the transfer of ice to drinks. Stores up to 480kg of ice. Easy to clean thanks to seamless one-piece vat design with rounded corners. Drainage system designed to collect and direct water to the drain keeping the bin clean and dry. Hard sanitary polyethylene one piece liner, resistant to blows and scratches. Use a stacking kit to double stack two modular heads in order to double production capabilities and achieve ultimate space utilisation. Filter systems need to be installed with the ice machine to protect the 2-year parts and Labour warranty. Best suited to: Restaurants / Cafes, Clubs / Pubs / Bars, Quick Service Restaurants, Convenience / Petrol / Supermarkets, Food Production, Hospitality / Venues, Accommodation, Schools, Medical / Aged Care, Bakery / Pastry.

Supplied Accessories



Water Inlet
Hose



Drain Hose



Drainage
Elbow



Large
Scoop



Adjustable Height
Legs



Warranty



Watermark

A Watermark approved* water filter, suitable for the water type at the place of installation must be used. SKOPE can provide a water filter that protects the Ice Maker, and ensures proper function and high quality ice production. Service or repair due to absence of a suitable water filter will not be covered by SKOPE warranty. Contact SKOPE for more information.

*Watermark approval is only applicable to Australian installations. Elsewhere, a suitable water filter must be used